



Postural Assessment of Indian Excavation Workers and Prototype Design of Virtual Iron-Pan







Manoj T. Gajbhiye¹, Suman Das^{2*}, Chandan Das³ and Debamalya Banerjee¹



¹Department of Production Engineering, Jadavpur University, Kolkata (W.B.), India;

²Department of Mechanical Engineering, Swami Vivekananda Institute of Science & Technology, Kolkata (W.B.), India; ³Kamala Engineering Works, West Bengal, India

E-mail/Orcid Id:

MTG,  manojtjgajbhiye28@gmail.com,  <https://orcid.org/0000-0001-6632-2318>; SD,  sd_suman@yahoo.co.in,  <https://orcid.org/0000-0002-7796-2852>;
CD,  howrah05@gmail.com; DB,  debamalya_banerjee@yahoo.co.uk,  <https://orcid.org/0000-0003-2131-2225>

Article History:

Received: 17th Oct., 2023

Accepted: 19th Dec., 2023

Published: 30th Dec., 2023

Keywords:

Biomechanical, Excavation, Lifting, Postural Assessment, REBA, RULA

How to cite this Article:

Manoj T. Gajbhiye, Suman Das, Chandan Das, Debamalya Banerjee (2023). Postural Assessment of Indian Excavation Workers and Prototype Design of Virtual Iron-Pan. *International Journal of Experimental Research and Review*, 36, 388-404.

DOI:

<https://doi.org/10.52756/ijerr.2023.v36.034>

Abstract: The study was conducted among excavation labourers of the construction sites for five different tasks. Five postures were selected from the video recorded at the time of data collection. Analysis of static/dynamic working postures and loads on the various body parts are being done using computer software's which is not possible manually nowadays. In this study, the postures of excavation labourers were assessed using CATIA software during five various excavation operations. Digital Human Analysis (DHM) was developed in the CATIA software for study. RULA, REBA, biomechanical and lifting analysis were performed to detect body risk and loads on the L4/L5 segment of the vertebral column. CATIA software reveals that the excavation labourers are working at high risk. The result evaluated by RULA and REBA for all five working postures indicates that all postures require investigation and need immediate change. The result shows that biomechanical loads at the L4/L5 segments are higher than the NIOSH recommended limit for the task of throwing soil and receiving the pan by some outside labourers. Almost the same effect was observed when lifting of iron-pan where the labourers work in the flexion position. New prototype iron-pan was developed and re-analysis to compare the results with new working techniques in CATIA. This showed that the prototype iron-pan proposed helps to reduce the ergonomic risk during excavation and related work. The CATIA software also provides better results by better evaluation of working postures of labourers at excavation sites.

Introduction

Foundation is primary function of all construction work which is support of house. This is deep at least 1500 mm from the surface. This included digging of ground to make pit in the ground to place foundation and thereby erection of column pit. In India, large numbers of construction work performed manually and excavation is one the activity although new and modern technologies developed to perform construction work. The construction work in India still needs human involvement which requires heavy physical work. During construction work, labourers have to work in awkward postures, perform repetitive work, lifting and lowering, transportation of materials, working in standing positions, work over the shoulders, working in high and low

temperature, work without support etc which is very frequent. Also, these workers are suffering from WRMSD due to lack of knowledge, proper training and guidance and properly designed ergonomic tools and equipment as well as poor habits (Gajbhiye et al., 2022). While performing excavation work, labourers experience all above mentioned things. Studies have shown that the above-mentioned functions lead to the severe accidents and development of work-related musculoskeletal disorders (WRMSD'S) (Anti-Afari et al., 2017; Chen et al., 2017; Roman-Liu, 2014; Valero et al., 2014; Kim et al., 2014). In India alone, 24.20% casualty occurs every year due to various construction risk factors (Patel et al., 2016).

*Corresponding Author: sd_suman@yahoo.co.in



This work is licensed under a Creative Commons Attribution-NonCommercial-NoDerivatives 4.0 International License.

When the excavation is in progress, the labourers have to perform excavation of soil (trench/dig), collect excavated soil in iron-pan, lift iron-pan, throw excavated soil outside pit or pass the head-pan to the labourer standing at the surface of the pit when work deep inside the pit. All of these jobs are dynamic in nature and require high physical exertion for excavation and lifting. In India, men and women manually do this dangerous, forceful and dynamic work.

Single labourer himself perform all the activities of the excavation and throwing of soil outside the pit however extra labourer deploy when work deep inside the pit. This work takes three to four days to dig/trench the pit of size 1500mm x 1500mm x 1800mm by the single labourer. Labourers use axe to dig the soil, iron-pan and spades to collect the excavated soil in the iron-pan.

The labourers lift the iron-pan by hand from the ground level to throw the soil outside the pit and when the labourer unable to perform the throwing operation, the extra labourers deploy and handed out the iron-pan to him to throw the excavated soil by standing near the pit at the surface level.

Evaluating such dynamic, forceful and repetitive work is not possible without use of computer software which is able design, performs simulation and carries out assessment of working posture. The factors like intense lifting, monotonous and repetitive work, insufficient relaxation moment, forceful physical effort and perform activities in awkward postures for prolonged period of time are the responsible for enforcing high biomechanical force on labourer's body. This is also responsible for progress of work-related musculoskeletal disorders, permanent or quasi disability and causality on construction site. Assessment of such biomechanical forces is not probable manually and required computer interference. CATIA is able to provide different ergonomic analysis covering all aspects of machine and human. Many older methods have also been upgraded as needed and for better results (Figlani et al., 2015; Kivi et al., 1991; Kushwaha et al., 2016; Pavlovic-Veselinovic et al., 2016; Sanchez-Lite et al., 2013; Tahmasebi et al., 2017; Veljovic et al., 2019).

RULA, REBA and CATIA provide a perfect evaluation of stresses on different body parts in the practical scenario. This paper uses a computer-aided three-dimensional interactive application (CATIA), human simulation software that validates a three-dimensional (3D) model of body posture detail analysis.

Therefore, in this paper RULA worksheets, REBA worksheets and CATIA software used in an attempt to assess ergonomics risk for the real lift awkward postures of Indian excavation labourers. Also,

biomechanical and lifting analysis was performed on the real-life work postures of the labourers by developing manikin of the real-life postures of the excavation labourers in CATIA. Later, a new iron-pan designed in CATIA and the analysis carried out on manikin while using newly developed iron-pan to see the differences in the results. RULA and REBA analysis performed using worksheets on the manikin as well as biomechanical and lifting analyses were done on the manikin using CATIA software tools for various excavation works using newly designed iron-pan.

Materials and Methods

Over four weeks, 54 labourers were studied, observed, recorded and interviewed at various construction sites. Labourers' information and feelings of discomfort and other related issues were discussed with the labourers using a simple questionnaire. Also, the weight of the empty and filled iron-pan, weight of the spade is weighed and recorded. The questionnaire was designed in such a way that it would help to know the frequency of WRMSD and other discomforts in the body parts. RULA and REBA worksheets were used to evaluate the ergonomic risk of excavation labourers while performing various excavation works. CATIA V5 software was also used to develop and analyse selected high-risk manikins of selected real-time images of the labourers. The work of collection of soil in the iron-pan, lifting of iron-pan, throwing of collected soil out of the pit, handing over the iron-pan to outside labourers, obtaining the iron-pan by outside labourers and dumping of soil by the outside labourers were developed and analysed on the manikin developed in CATIA. After the result obtained from RULA, REBA and CATIA, a new iron-pan was designed and modelled in CATIA. The manikin was also developed in the CATIA and a variety of postures were created and analysed for different working postures using newly designed iron-pan. The evaluation of RULA, REBA, biomechanical and lifting was performed on the jobs 1) collection of soil in the newly designed iron-pan 2) lifting of newly designed iron-pan from the ground level for the weight 20kg, 15kg and 10kg 3) Throwing of soil by the inside labourers or passing of newly designed iron-pan to the outside labourers when the head-pan is at the shoulder level for the weight 20kg, 15kg and 10kg 4) receiving of the iron-pan by the outside labourers for the weight 20kg, 15kg, and 10kg and 5) lifting analysis of the manikin for job 2, job 3 and job 4 for the same weight lifting. For analysis, repetition, static muscle load, force, working postures and no break time are considered while developing computer manikin. The standard rule of

anthropometry is set as per the rules. Green, yellow, orange and red colour designated for "acceptable posture", "Need further investigation and change", "Need further investigation and change soon" and "need investigation and change immediately" respectively (Hlavkova et al., 2016).

Results

The studied workers were doing manual excavation work at different construction sites. Table 1 shows the workers' age (years), height (cm), weight (kg), experience (years), BMI (kg/m²), working hours and rest hour. The duration of working hours depends on the demand for work, but the standard daily working hours are 9 (\pm 1) and rest 1 (\pm 30 minutes). Workers' BMI was found to be in the range of 18 to 25 kg/m², however, six workers were found to be above the BMI limit ($>$ 25kg/m²).

Table 1. Somatic Characteristics of workers

Characters	Mean (\pm SD)
Age (years)	39.67 (\pm 9.43)
Height (cm)	161.52 (\pm 5.74)
Weight (kg)	58.81 (\pm 6.91)
Work Experience (years)	16.22 (\pm 9.71)
BMI (kg/m ²)	22.52 (\pm 2.11)
Working hours/day (hours)	9 (\pm 1)
Rest hours/day (hours)	1 (\pm 30min)

According to the Table 2, most affected body part is the lower back (85%), shoulders (85%) and arms / hands (74%). Trauma was also reported in the wrist (31%), chest (26%), fingers / toes (24%), and neck (19%). and Figure 1 also showed that among all the body parts lower back (22%), shoulder (22%) and arms/hand (19%) are mostly affecting. From the video recording it is also observed all labourers were working in awkward postures. When the labourers worked deep inside the column pit, it is noticed that the labourers were having trouble in breathing. From the survey report, it is observed that about 90 % labourers were migrated from other states; about 80% labourers were addicted to tobacco/alcohol/smoking. About all age grouped labourers were reported pain in different body parts except upper back, thigh, hip, buttock, knees, ankle, feet and toes. From the study it is also revealed that 48.15% labourers have pain after working, 18.52 labourers have pain in the morning, 14.81% labourers have in during working and 11.11% labourers have pain during sleeping.

Table 2. Workers reply to pain/discomfort (N=54)

Body Parts	Number of workers	% of workers
Head	7	13
Neck	10	19
Shoulder	46	85
Chest	14	26
Elbow	2	4
Arms/Hands	40	74
Wrist	17	31
Fingers/Thumbs	13	24
Upper Back	0	0
Lower Back	46	85
Thigh/Hip/Buttock	0	0
Legs	17	31
Knees	0	0
Ankle/Feet/Toe	0	0

For evaluation, five postures were selected for the study 1) soil collection in the iron-pan (Job-1), 2) iron-pan lifting (Job-2), 3) throwing of soil outside the pit or pass the iron-pan to the outside labourer (Job-3), 4) Iron-pan receive by the outside labourer (Job-4) and 5) dumping of soil by the outside workers (Job-5). The labourers do the work of collecting soil, lifting the pan and throwing the soil himself. An additional labourer is required when the worker unable to throw the excavated soil out of the column. Figure 2(i)-2(vi) shows the real-time images of excavation work and jobs considered for analysis.

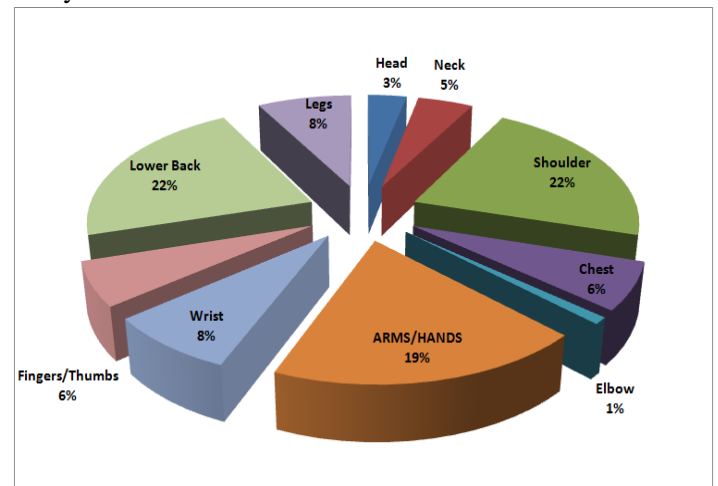

Figure 1. Number and percentage of worker reply to pain/discomfort

Working practice, RULA, REBA, Biomechanical and lifting assessment of various jobs Soil collection in the iron-pan

In this job, labourers use a spade to collect the excavated soil in an iron-pan to throw it out of the pit of the column. During this Job, the trunk of labourers is in the forward flexion position at the lumbar with more than



Figure 2. Actual images of performing excavation and associated work

- (i) Labourers performing various excavation work, (ii) Labourer performing collection of soil in Iron-Pan (Job-1), (iii) Labourer performing lifting of Iron-pan (Job-2), ((iv) a & b) Labourer performing soil throwing / passing Iron-pan to outside labourer (Job-3), (v) Outside labourer receive Iron-pan from Inside labour (Job-4), ((vi)a & b) Outside labourer dumping soil (Job-5)**

90°. Both arms/hands of the labourers are below shoulder level while the wrist is under ulnar deviation and legs are abducted position on the thighs and in flexion position to 30°-60° at knees position. (Figure 2(ii))

The score obtained from the RULA and REBA shows that this job is at very high risk and need instant change. The biomechanical result shows that moment about L4/L5 (M) is 75 Nm, compression on L4/L5 (C) is 1063 N and Joint shear about L4/L5 (JS) is 385 N (A). While abdominal force (AF) and abdominal pressure (AP) for real-time posture developed are 48 N and 2 N/m² respectively.

Lift the iron-pan

After collecting the soil in the iron-pan, the labourer has to lift the iron-pan from the ground. The labourer throws the soil outside the pit. When the labourer cannot throw the collected soil outside the pit, an iron-pan is

given to the labourer standing outside the pit of the surface. In this work, the labourers lean forward from the lumbar more than 90° and arms below shoulder level. The labourer often works in the twisted position from the lumbar. The labourer works with the position of extended trunk, neck and wrist more than 45°. When lifting the iron-pan, the entire load of the iron-pan falls on the hands of the labourers. Labourers hold the iron-pan at the height of the elbow, then at shoulder height and then at the top of the shoulder. Both legs are in a position of abduction from the thighs and flexion posture at the knee (>60°) (Figure 2(iii)).

The score obtained from the RULA and REBA shows that this job is at very high risk and need instant change. The biomechanical result show that moment about L4/L5 (M) is 156 Nm, the compression on L4/L5 (C) is 2587 N and Joint shear about L4/L5 (JS) is 379 N (A). Abdominal force (AF) and abdominal pressure (AP) are 75 N and 3 N/m² respectively.

Table 4. REBA Score

BP	Job 1		Job 2		Job 3		Job 4		Job 5	
	L	R	L	R	L	R	L	R	L	R
UA	3	2	3	3	5	5	4	4	4	4
LA	3	3	2	2	2	2	2	2	2	2
W	3	3	3	3	4	4	3	3	3	3
WT	2	2	2	2	2	2	2	2	2	2
SC(A)	5	4	4	4	7	7	5	5	5	5
M	1	1	1	1	1	1	1	1	1	1
F	1	1	3	3	3	3	3	3	3	3
SC(C)	7	6	8	8	11	11	9	9	9	9
N	5		5		5		5		5	
BK/T	5		5		2		5		4	
L	2		2		2		2		2	
SC(B)	8		8		7		8		8	
M	1		1		1		1		1	
F	1		3		3		3		3	
SC(D)	10		12		11		12		12	
RLS	> 7*	> 7*	> 7*	> 7*	> 7*	> 7*	> 7*	> 7*	> 7*	> 7*
Low Risk - \$, Medium Risk - @, High Risk - #, Very High Risk - *										
UA - Upper Arm, LA-Lower Arm, W-Wrist, WT-Wrist Twist, SC(A)- Score in Table-A, M-MUSCLE SCORE, F-Force, SC(C)- Score in Table-C, N-Neck, BK/T-Back/Trunk, L- Legs, SC(B)- Score in Table-B, SC(D)- Score in Table-D RLS-RULA Score										

Throwing of soil outside the pit / pass the iron-pan to outside labourer

In this work, the labourer then picks up the iron-pan, pour the soil out of the column pit when the pit is shallow. As soon as the column pit reaches deep inside, the labourer gives the iron-pan to the labourer standing near the column on the surface. While performing this, the labourers are in an extended posture of the vertebra with the arms are above shoulder height and the neck in an extended posture. The legs are abducted at thigh. (Figure 2(iv) (a)(b))

RULA and REBA scores obtained for this job shows that this job is also at very high risk and need immediate change. The biomechanical result show that moment about L4/L5 (M) is -28 Nm, the compression on L4/L5 (C) is 1032 N and Joint shear about L4/L5 (JS) is 50 N (A). Abdominal force (AF) and abdominal pressure (AP) are 0 N and 0 N/m² respectively.

Receive iron-pan by outside labourer

When the pit goes deep and the labourer are unable to get the soil out of the column pit, the labourer standing near the surface of column pit takes the iron-pan from the

labourer working in the column pit. During this job, the labourer bends about 60° in the flexion position with more than 20° vertebral rotations. The spine and neck are found in the extension postures while arms are perpendicular and are above the shoulders. One of the legs is at the plain surface through 30°-60° flexions and other is above the dumped soil with 60° flexion posture. The right leg is abducted to some extent at the thigh and flexion 90° at the knee (Figure 2 (v))

The RULA and REBA scores for this job show that this job is also at very high risk and need immediate change. The biomechanical result show that moment about L4/L5 (M) is 116 Nm, the compression on L4/L5 (C) is 3530 N and Joint shear about L4/L5 (JS) is 109 N (A). Abdominal force (AF) and abdominal pressure (AP) are 0 N and 0 N/m² respectively.

Throwing soil to dump by the outside labourer:

The posture of this job is shown in Figure 2 ((vi)(a)(b)) in which it is appears that the surface becomes rough and uneven after pouring the soil. The outside labourer is standing on an uneven plan, one foot on a flat plan and the other one and a half feet above the

Table 4. REBA Score

	Job 1	Job 2	Job 3	Job 4	Job 5
N	3	3	3	3	3
BK/T	5	5	3	5	4
L	3	4	2	4	4
PS(A)	9	9	6	9	9
F	1	2	2	2	2
TS(A)	10	11	8	11	11
UA	2	2	5	5	3
LA	1	2	2	2	2
W	2	2	2	2	2
PS(B)	2	3	8	8	5
CP	0	2	2	2	2
TS(B)	2	5	10	10	7
TS(C)	10	12	11	12	12
A	1	1	1	1	1
RBS	11*	13*	12*	13*	13*
Low Risk-\$, Medium Risk - @, High Risk - #, Very High Risk - *					
N-Neck, BK/T-Back/Trunk, L- Legs, PS(A)- Posture score in Table A, F-Force, TS(A)- Total Score of A, UA - Upper Arm, LA-Lower Arm, W-Wrist, PS(B)- Posture score in Table B, CP-Coupling Score, TS(B)- Total Score of B, TS(C)- Total score from Table C, A- Activity Score, RBS-REBA Score					

flat plan. In this posture, the labourers right leg is in an upright position, while the left leg is flexion position and at abducted position at thigh and flexion at knee. The hands are holding the iron-pan above shoulder level and wrists are in an extended posture.

The RULA and REBA scores for this job show that this job is also at very high risk and need immediate action to change the working posture. The biomechanical result shows that moment about L4/L5 (M) is 260 Nm, the compression on L4/L5 is 5719 N and Joint shear about L4/L5 is 202 N (A). Abdominal force and abdominal pressure are 183 N and 6 N/m² respectively.

RULA and REBA Analysis

RULA and REBA scores monitored with job repetitions, static load on muscle load, awkward working postures and no rest time. Table 3 and Table 4 show the final scores of RULA and REBA for all five tasks. RULA's result were found to be more than 7 for all jobs and 11 for REBA, which revealed that it needs investigation and needed immediate change. The RULA and REBA score shows that the neck, trunk and legs are mainly affected on both the left and right sides of the body while performing job-1, Job-2 and Job-4. Job-3 mostly affects the wrists and hands while Job-5 affecting lumbar and shoulder. The RULA and REBA score indicates that the neck, trunk and lumbar parts and legs are mainly affected by working in awkward posture.

Biomechanical Analysis

Biomechanical analysis is performed to calculate and report lumbar spinal loads such as moments about L4/L5, compression on L4/L5, Body load compression, Axial Twist compression, Flexion/Extension compression, Joint shear about L4/L5, abdominal force, abdominal pressure, body movements developed for real-time posture. All the output of the designed model is based on scientific research data. Figure 3 (i) - (v) and Table 5 show the results of the biomechanical single action analysis for all five jobs of the excavation work.

Table 5 shows the biomechanical analysis results for all five tasks. The maximum lumbar torque at L4/L5 is found as 75 Nm, 156 Nm, -28 Nm, 116 Nm and 260 Nm and compression at L4/L5 is found as 1063 N, 2587 N, 1032 N, 3530 N and 5719 N for Job-1, Job-2, Job-3, Job-4 and Job-5. The compression of L4/L5 for Job-1, Job-2 and Job-3 are below the maximum allowable compression force but are more in Job-4 and Job-5.

Joint shear load at L4/L5 is found 385 N (Anterior), 379 N (Anterior), 50 N (Anterior), 109 N (Anterior) and 202 N (Anterior), in a Job-1, Job-2, Job-3, Job-4 and Job-5. The joint shear load is more for Job-1, Job-2, and Job-5 as these labourers work by bending in forward (flexion) position for prolong period of instance. The joint shear load in the Job-3 and Job-4 is found less than the other three tasks 50 N (Anterior) and 109 N (Anterior) with no abdominal force and pressure applying on these jobs.

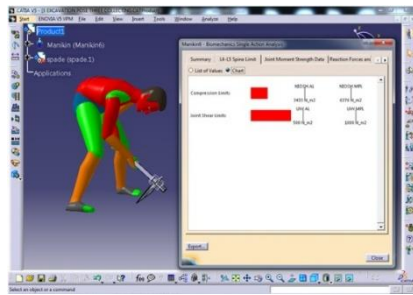

3(i). Soil collection in the Iron-pan

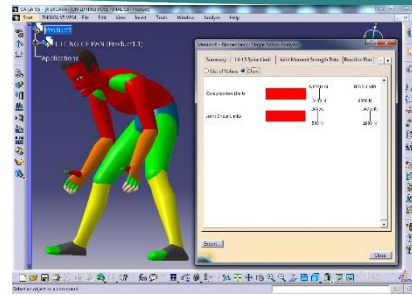

3(ii). lifting of pan

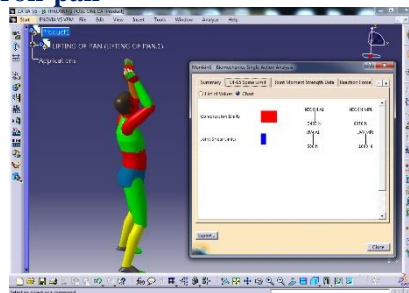

3(iii). Throwing of soil outside the pit / pass the iron-pan to outside labourer

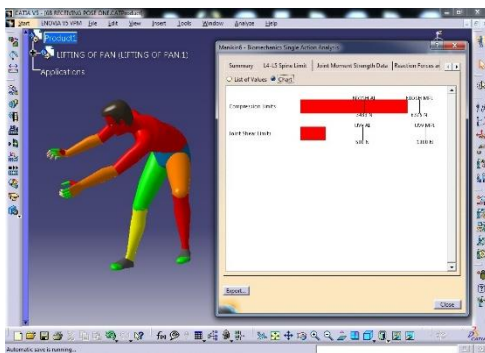

3(iv). Receiving of iron-pan by the outside labourer

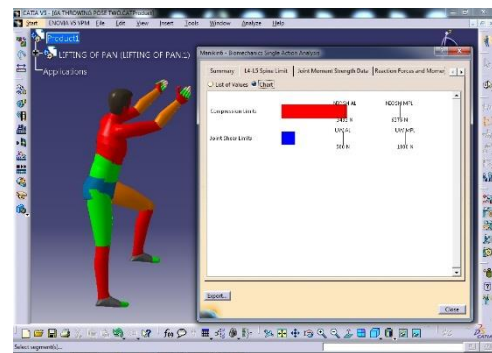

3(v). Throwing of soil by the outside labourer

Figure 3. (i, ii, iii, iv, v) Biomechanical analysis for all five Jobs

Table 5. Biomechanical analysis results of all five jobs

	Job 1	Job 2	Job 3	Job 4	Job 5
M (Nm)	75	156	-28	116	260
C (N)	1063	2587	1032	3530	5719
BLC (N)	-351	-49	604	606	179
ATC (N)	46	25	3	30	572
F/EC (N)	1249	2605	335	1938	4336
JS (N)	385 (A)	379 (A)	50 (A)	109(A)	202 (A)
AF (N)	48	75	0	0	183
AP (N/m ²)	2	3	0	0	6

M - Moments about L4/L5, C - Compression on L4/L5, BLC - Body load compression, ATC - Axial Twist compression, F/EC - Flexion/Extension compression, JS - Joint shear about L4/L5, AF - Abdominal force, AP - Abdominal pressure

The detailed biomechanical analysis is shown in Table 5. The tasks, where workers need to be work in the flexion position (more than 90⁰) for a maximum period is not acceptable and need to minimise as an application of shear force is more

Lifting Analysis

Lifting analysis is performed to identify the risk of physical stress associated with manual lifting. The National Institute for Occupational Safety and Health has developed and recommended some standard lifting

equations with recommended weight limits and lifting index (Waters et al., 1993).

The manikin developed in CATIA V5 was studied for the lifting of the filled iron-pan from the ground level to the overhead to pour soil outside the column pit or to hand over the iron-pan to labour standing outside the column pit at the surface level (figure 4). Labourers fill and lift 15 to 20 kg weight every 60 seconds throughout the day except for the rest period. The iron-pan is hemispherical in shape and has no handle to hold the iron-pan so the labourers have to hold the iron-pan from the bottom. The labourers lift a pan weighing an average of 20 kg which contains the weight of an iron-pan and soil. The posture analysed according to NIOSH 1991 guidelines (Table 6).



Figure 4. Result of lifting of pan as per NIOSH 1991 guidelines

The results indicate that the recommended weight limit (RWL) (11.967 kg) and the lifting index (1.67) are higher than the recommended level (<1), and that the foot-to-foot coupling is also not in the proper position.

Table 6. Lifting pan from ground

Parameters	Values
Recommended weight limit (RWL) (1991)	11.967 kg
Lifting Index (LI) (1991)	1.67
Poor foot to foot coupling in final posture	

New prototype design of iron-pan and technique

The new prototype iron-pan was designed and modeled at CATIA. Figure 5 (i) and (ii) show detailed prototype iron-pan drawing. RULA, REBA, biomechanical and lifting analysis is done by modeling manikin for various jobs using this prototype iron-pan as shown in figure 6-11. All the analysis done using newly developed iron-pan on manikin 1) collection of soil in the iron-pan 2a) Lifting of iron-pan from the ground level when weight is 20 kg, 2b) Lifting of iron-pan from the ground level when weight is 15 kg, 2c) Lifting of iron-pan from the ground level when weight is 10 kg, 3a) Throwing of the soil outside the column pit or hand over the iron-pan to the outside labourer when iron-pan is at

shoulder level and weight is 20 kg, 3b) Throwing of the soil outside the column pit or hand over the iron-pan to the outside labourer when iron-pan is at shoulder level and weight is 15 kg, 3c) Throwing of the soil outside the column pit or hand over the iron-pan to the outside labourer when iron-pan is at shoulder level and weight is 10 kg, 4a) Receive iron-pan by the outside labourer when weight of the pan is 20 kg, 4b) Receive iron-pan by the outside labourer when weight of the pan is 15 kg and 4c) Receive pan by the outside labourer when weight of the pan is 10 kg was done.

Design of new prototype Iron-Pan

Labourers have to work harder to lift the iron-pan filled with the excavated soil weighing about 15-20 kg and finally the biomechanical force works on the vertebra of the labourers. To reduce this, the prototype design of the iron-pan has been developed and modelled. Replace the round pan with a trapezium shaped iron-pan by providing adjustable vertical handle as shown in figure 5 (i) & (ii). A detailed drawing of the iron-pan is shown in figure 5(i) & (ii) where the length of the pan is 400 mm, the width of the front pan is 400 mm and the rear is 300mm. The height of the front side of the pan is 75 mm and that of the rear side is 150mm. On the back of the pan, a handle 850 mm high and 80 mm wide is fixed from the bottom which can be easily handled/gripped using a round rubber handle. Also, the handle length of the spade was increased from 600 mm to 800 mm to avoid further bending. At the top of the handle, an elliptical handle is provided for proper grip. The length of the handle can vary between 400 mm to 850 mm as per requirement.

Soil collection in the new prototype iron-pan

The 850 mm long handle on the newly developed iron-pan and the spade handle length is 800 mm, so there is no need to bend forward from the lumbar position. Also, flattening the base of the newly developed iron-pan allows the iron-pan to rest comfortably on the ground, so newly developed iron-pan does not need to provide the extra support as required in the conventional round shape iron-pan (Figure 6).

RULA and REBA score obtained from the worksheet shows medium and low risk respectively while working with this posture using a newly proposed iron-pan. The biomechanical score of the same shows 1258 N compression and 76 N (A) joint shear load on L4/L5. These two values are found within the maximum permissible limits and within acceptable region. Although the compression force on the L4/15 appears to be increase but joint shear load is greatly. The abdominal force and pressure also become zero while using this iron-pan.

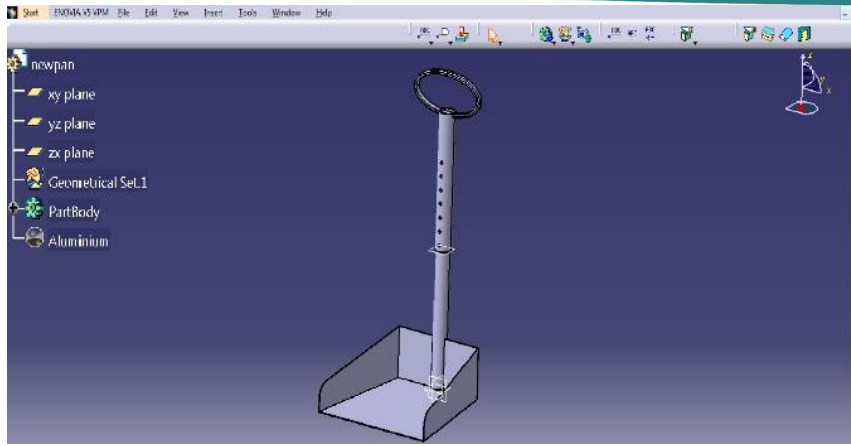

(i)

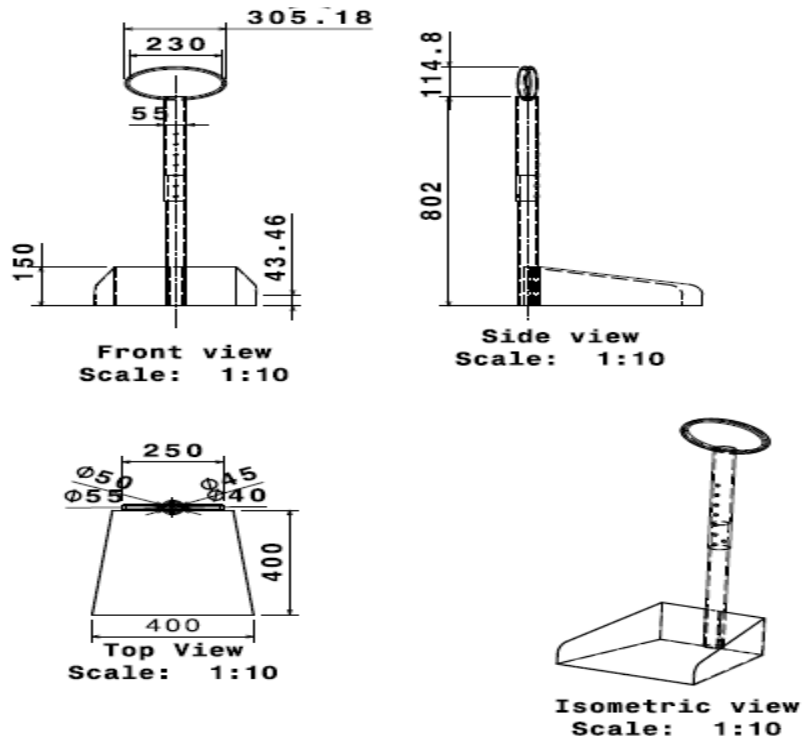

(ii)

(All dimensions are in mm)

Figure 5. New prototype virtual design of pan

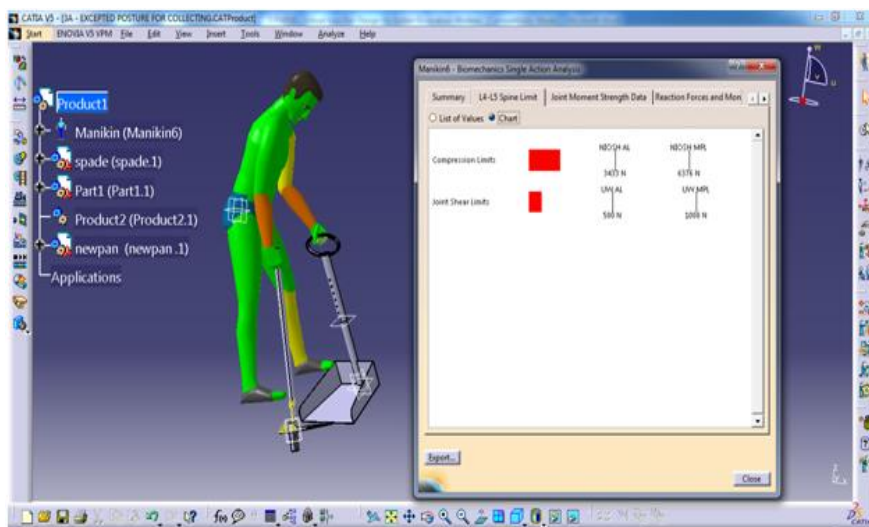

Figure 6. Collection of soil in the new prototype pan

Lifting of new prototype iron-pan from ground level

The new prototype iron-pan lift was analyzed in three ways.

1) Lifting of iron-pan from the ground level when weight is 20 kg (Job-2a), 2) Lifting of iron-pan from the ground level when weight is 15 kg (Job-2b) and 3) Lifting of iron-pan from the ground level when weight is 10 kg (Job-2c). (Figure 7(i)-(iii))

From Table 7, the RULA score obtained from the worksheet shows that the job is at medium to high risk. The RULA score indicates that when labour lifts a weight of 20 kg from the ground level, the posture adopted by the labourer is at high risk, but as the weight decreases to 15kg and 10 kg, the risk is reduced to medium risk. From Table 8, the REBA score obtained from the worksheet shows that the job has medium risk for 20kg, 15kg and 10kg weight to be lifted.

The result of biomechanical analysis shows that the compression force at L4/L5 is 2398 N, 2189 N and 1981 N for lifting weights of 20kg, 15kg and 10kg from ground level respectively. Joint shear loads at L4/L5 obtained 308 N, 284 N and 260 N for lifting the same weight. Both results show that the compression and shear force decrease while using newly developed iron-pan.

Throwing of soil or passing of new prototype iron-pan to outside labourers

The throwing of soil outside the pit or passing of iron-pan to the outside labourer was analysed also in three ways.

1) 3a) Throwing of the soil outside the column pit or handing over the iron-pan to the outside labourer when iron-pan is at shoulder level and weight is 20 kg (Job-3a), 3b) Throwing of the soil outside the column pit or hand over the iron-pan to the outside labourer when iron-pan is at shoulder level and weight is 15 kg (Job-3b), 3c) Throwing of the soil outside the column pit or hand over the iron-pan to the outside labourer when iron-pan is at shoulder level and weight is 10 kg (Job-3c). (Figure 8(i)-(iii))

The analysis was performed when the iron-pan was at chest level for three different weights. From Table 7, the RULA score obtained from the worksheet shows that the job is at medium to high risk. The RULA score indicates that when labour hold the weight of 20kg and 15kg at chest level, the posture adopted by the labourer is at high risk, however as the weight decreases to 10 kg, the risk is

reduced to medium. From Table 8, the REBA score obtained from the worksheet shows that the job has medium risk for 20kg and 15kg and at low risk for 10kg weight to be lifted.

The outcome of biomechanical analysis show that when the iron-pan is at chest level, the compression force at L4/L5 is 2922 N, 2501 N and 2080 N for weights of 20kg, 15kg and 10kg for throwing the soil outside the pit or passing the iron-pan to the outside labourer respectively. Joint shear loads at L4/L5 obtained 52 N, 32 N and 13 N for holding same weight at chest level. Both results show that the compression force increases while joint shear load decrease using newly developed iron pan for the weight 15 kg and 10 kg when iron-pan is at chest level.

Receiving of new prototype pan

The receiving of the iron-pan by the outside labourer was also analysed in three ways.

1) 4a) Receive iron-pan by the outside labourer when weight of the pan is 20 kg (Job-4a), 4b) Receive iron-pan by the outside labourer when weight of the pan is 15 kg (Job-4b) and 4c) Receive pan by the outside labourer when weight of the pan is 10 kg was done (Job-4c) (Figure 8(i)-(iii)).

When receiving or lifting 20 kg, 15kg and 10kg of weight, the score obtained from the RULA worksheet shows that the labourers are at very high, high and medium risk. However, the REBA worksheet score shows that labourers are at medium risk. In this case, as the weight reduces, the score declines.

The compression force at L4/L5 decreases to 3133 N from 3530 N when collecting or lifting the Iron-Pan of weight 20 kg, which is under the maximum allowable limit. The compression force at L4/L5 is 2783 N and 2433 N when the labourers receive or lift the Iron-Pan of weight 15 kg and 10 kg from the inside labourer. Both these loads are under maximum allowable limits. For receiving or lifting 20 kg of weight, the joint shear load is 205 N; for 15kg, it is 196 N; and for 10 kg, it is 187 N. Though the joint shear load seems to increase but, it is under the maximum allowable limit. In this job, compression at L4/L5 reduces as the weight reduces. Hence, from the result, it is found that the lifting weight is the main cause for the development of WRMSD among construction labourers.

Table 7. RULA score after modification

		UA	LA	W	W T	SC (A)	M	F	SC (C)	N	BK /T	L	SC (B)	M	F	SC (D)	RL S
Job 1		1	2	1	1	2	0	1	5	1	2	2	3	0	0	3	4@
Job 2	a)	1	1	2	1	2	0	3	5	1	2	1	2	0	3	5	6#
	b)	1	1	2	1	2	0	2	4	1	2	1	2	0	2	4	4@
	c)	1	1	2	1	2	0	1	3	1	2	1	2	1	1	3	3@
Job 3	a)	4	2	2	1	4	0	3	7	1	1	1	1	0	3	4	6#
	b)	4	2	2	1	4	0	2	6	1	1	1	1	0	2	3	5#
	c)	4	2	2	1	4	0	1	5	1	1	1	1	0	1	2	4@
Job 4	a)	2	2	2	1	3	1	3	7	1	2	1	2	0	3	5	7*
	b)	2	2	2	1	3	1	2	6	1	2	1	2	0	2	4	6#
	c)	2	2	2	1	3	1	1	5	1	2	1	2	0	1	3	4@
Low Risk-\$, Medium Risk - @, High Risk - #, Very High Risk - *																	

Table 8. REBA Scores after modification

		N	BK /T	L	PS- A	F	TS- A	UA	LA	W	PS- B	CP	TS- B	TS-C	A	RB S
Job 1		1	2	1	3	0	3	1	2	1	1	0	1	2	1	3\$
Job 2	a)	2	3	1	4	2	6	1	1	1	1	0	1	1	1	7@
	b)	2	3	1	4	1	5	1	1	1	1	0	1	1	1	6@
	c)	2	3	1	4	0	4	1	1	1	1	0	1	1	1	5@
Job 3	a)	1	1	1	1	2	3	3	2	1	4	0	4	3	1	4@
	b)	1	1	1	1	1	2	3	2	1	4	0	4	3	1	4@
	c)	1	1	1	1	0	1	3	2	1	4	0	4	2	1	3\$
Job 4	a)	1	3	1	2	2	4	2	2	1	2	0	2	4	1	5@
	b)	1	3	1	2	1	3	2	2	1	2	0	2	3	1	4@
	c)	1	3	1	2	0	2	2	2	1	2	0	2	2	1	3@
Low Risk-\$, Medium Risk - @, High Risk - #, Very High Risk - *																

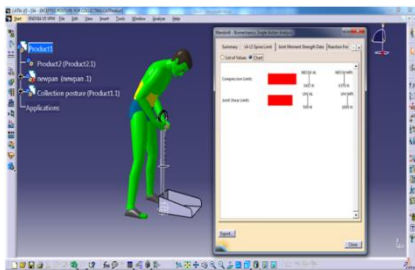

Figure 7(i). Lifting of head-pan from ground level (for 20 kg)

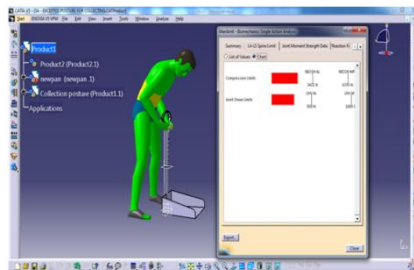

Figure 7(ii). Lifting of head-pan from ground level (for 15 kg)

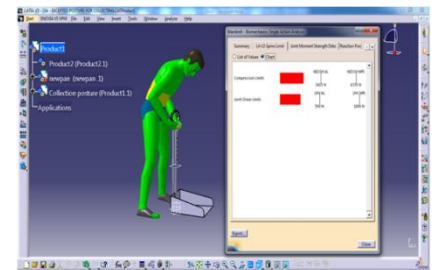

Figure 7(iii). Lifting of head-pan from ground level (for 10 kg)

Figure 7. Lifting of newly developed Iron-pan from ground level

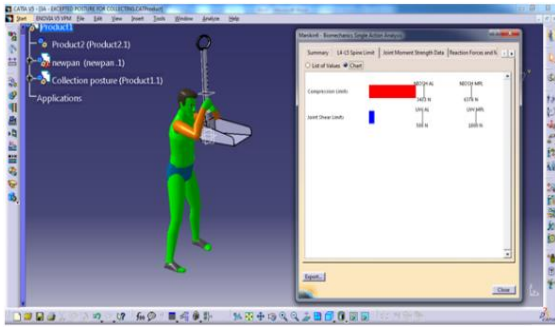

Figure 8(i). Throwing of soil labour/ passing head-pan to outside labour (Head pan at shoulder level - 20kg)

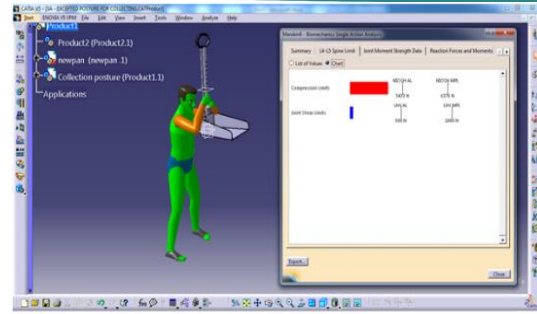

Figure 8(ii). Throwing of soil labour/ passing head-pan to outside labour (Head pan at shoulder level - 15kg)

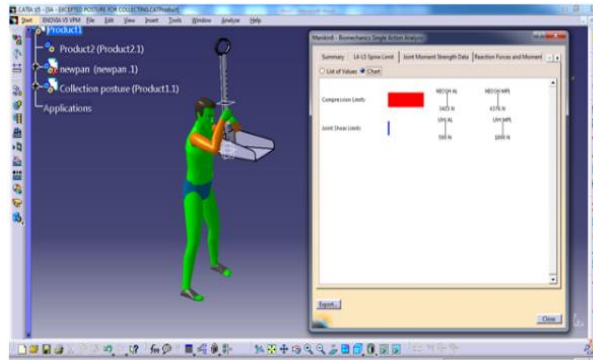

Figure 8(iii). Throwing of soil labour/ passing head-pan to outside labour (Head pan at shoulder level - 10kg)

Figure 8. Throwing of soil or passing of new prototype iron-pan to outside labourer

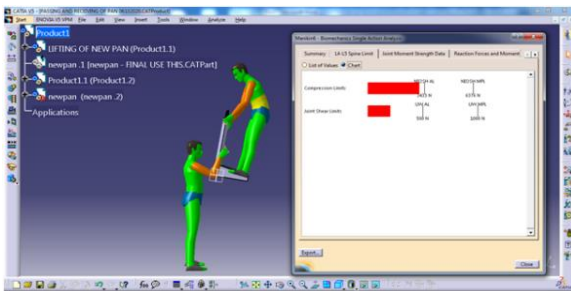

Figure 9(i). Receiving of the pan by the outside labourer (20 kg)

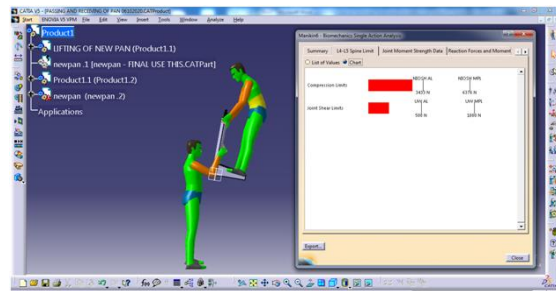

Figure 9(ii). Receiving of the pan by the outside labourer 15 kg)

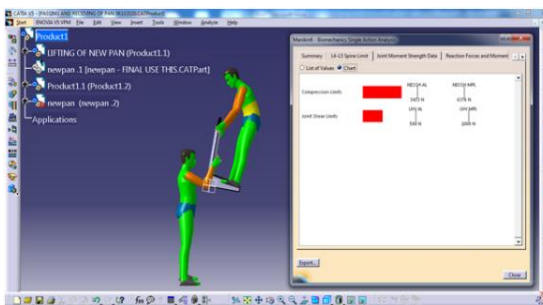

Figure 9(iii). Receiving of the pan by the outside labourer (10 kg)

Figure 9. Receiving of Pan by outside worker

Table 9. Biomechanical analysis results after modification

	Job 1	Job 2			Job 3			Job 4		
		(a)	(b)	(c)	(a)	(b)	(c)	(a)	(b)	(c)
Parameters		20 kg	15 kg	10 kg	20 kg	15 kg	10 kg	20 kg	15 kg	10 kg
M (Nm)	49	120	109	99	132	111	90	-157	-139	-121
C (N)	1258	2398	2189	1981	2922	2501	2080	3133	2783	2433
BLC (N)	385	371	341	312	592	545	497	427	393	358
ATC (N)	2	10	7	5	11	9	7	26	20	15
F/EC (N)	824	1997	1826	1655	2199	1849	1499	2615	2320	2024
JS (N)	76(A)	308(A)	284(A)	260(A)	52(P)	32(P)	13(P)	205(A)	196(A)	187(A)
AF (N)	0	0	0	0	0	0	0	0	0	0
AP (N/m²)	0	0	0	0	0	0	0	0	0	0



Figure 10(i). Lifting result when time per lift is 120 seconds for lifting 20 kg weight



Figure 10(ii). Lifting result when time per lift is 120 seconds for lifting 15 kg weight

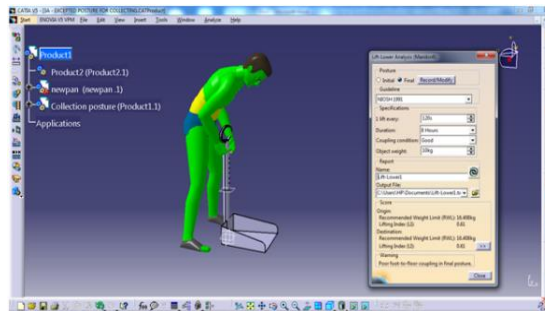

Figure 10(iii). Lifting result when time per lift is 120 seconds for lifting 10 kg weight

Figure 10. NIOSH 1991 Lifting result lifted from ground level

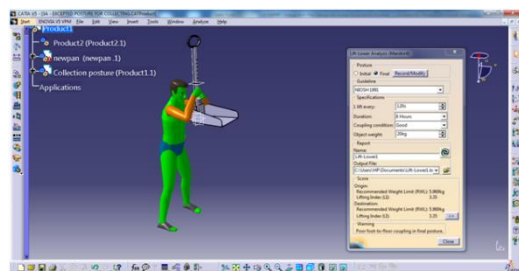

Figure 11(i): Lifting result when time per lift is 120 seconds for lifting 20 kg weight when pan at shoulder level

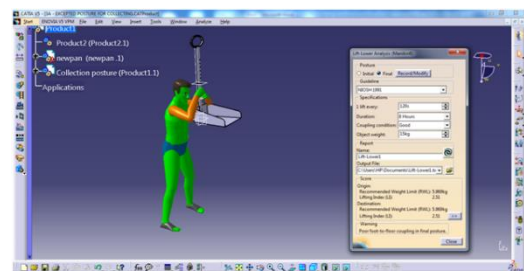

Figure 11(ii): Lifting result when time per lift is 120 seconds for lifting 15 kg weight when pan at shoulder level

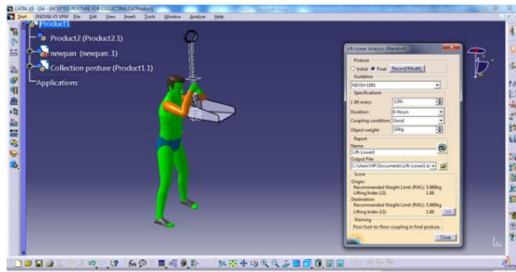

Figure 11(iii): Lifting result when time per lift is 120 seconds for lifting 10 kg weight when pan at shoulder level

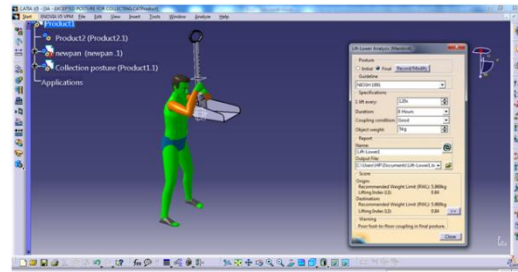

Figure 11(iv): Lifting result when time per lift is 120 seconds for lifting 5 kg weight when pan at shoulder level

Figure 11. NIOSH 1991 Lifting result when iron-pan at chest level of the inside labourer



Figure 12(i). Lifting result of external laborer when time per lift is 120 seconds for lifting 20 kg weight



Figure 12(ii). Lifting result of external laborer when time per lift is 120 seconds for lifting 15 kg weight



Figure 12(iii). Lifting result of external laborer when time per lift is 120 seconds for lifting 10 kg weight

Figure 12. NIOSH 1991 lifting result for an outside labourer

Table 10. Lifting analysis results after modification									
	Job 2			Job 3			Job 4		
	(a)	(b)	(c)	(a)	(b)	(c)	(a)	(b)	(c)
Parameters (Wt. Lifted/hold)	20 kg	15 kg	10 kg	20 kg	15 kg	10 kg	20 kg	15 kg	10 kg
Recommended weight limit (RWL) (1991)	16.408 kg	16.408 kg	16.408 kg	5.969 kg	5.969 kg	5.969 kg	11.945 kg	11.945 kg	11.945 kg
Lifting Index (LI) (1991)	1.22	0.91	0.61	3.35	2.51	1.68 (0.84 for 5kg)	1.67	1.26	0.84

Lifting analysis as per NIOSH 1991 using new prototype Iron-pan device

Table 10 shows the results of NIOSH lifting analysis for Job-2, Job-3 and Job-4 for 20kg, 15kg and 10kg weights. This lifting analysis was performed using NIOSH 1991 guidelines for lifting 20kg, 15kg, and 10kg with 120 seconds for each lift, 8 hours or more hours, excluding rest periods, and better coupling conditions. An analysis was also performed on Job-2 for 5kg weight to check differences in the results.

For job 2, the recommended weight limit (RWL) for lifting 20kg, 15kg and 10kg was 16.408 kg, while the lifting index (LI) for 20kg, 15kg, and 10kg was 1.22, 0.91 and 0.61, respectively. This result concludes that lifting a maximum weight of 15 kg and below is permissible for job 2. ((Figure 10 (i)-(iii))

Whereas, for Job-3, the recommended weight limit (RWL) for lifting 20kg, 15kg and 10 kg was 5.969 kg, while the lifting index (LI) for 20kg, 15kg, and 10kg was 3.35, 2.51 and 1.68, respectively. This result shows that 20kg, 15kg and 10kg weight lifting is not permissible for job 3. The experiment was performed to lift 5 kg of weight, and for this weight, RWL came to 5.969, with LI coming to 0.84, which is below the permissible limit. So, it can be concluded that lifting 6kg for job 3 will be permissible. ((Figure 11 (i)-(iv))

For Job-4, the recommended weight limit (RWL) for lifting 20kg, 15kg and 10 kg was 11.945 kg, while the lifting index (LI) for 20kg, 15kg, and 10kg was 1.67, 1.26 and 0.84, respectively. This result shows that lifting a maximum weight of 12 kg is permissible for job-4, and 15kg and 20 kg weight is not permissible as the LI of both was found to be more than 1 ((Figure 12 (i)-(iii)).

Discussion

As mentioned, excavation work involves various works that are dynamic, forceful, and injurious in nature. The factors like working in awkward posture, year, pervasive jobs, traumatic incidences and also age are responsible for the development of WRMSD (Gajbhiye et al., 2023). While performing various excavation tasks, there is tremendous stress and intense pressure on the body postures of the labourers, and they are working in awkward postures. Therefore, this paper uses CATIA to evaluate the postures of five excavation works.

RULA and REBA worksheet scores show that all the jobs are at very high risk. Initially, RULA and REBA scores indicate that the lumbar, shoulders and arms/hands were exposed to high ergonomics risk while working with conventional tools.

CATIA's biomechanical analysis has shown that the outside labourer has higher compression on L4/L5, which is higher than the maximum allowable compression for 3400 N. Although there is less compression on the L4/L5 of the vertebrae in the lifting task, the joint shear load is closer to the maximum allowable limit of 500 N at the same time as the weight increases. Labourers are working in the twisting posture while throwing soil and taking iron-pan from the labourer working inside the column pit. When collecting soil in an Iron-Pan and lifting the Iron-Pan, labourers bend forward more than 90°, which is not acceptable, and this forward bending angle must be reduced by improving the design of the Iron-Pan or the method of collection. According to the NIOSH 1991 guidelines, the lifting technique is considered poor if the lifting score is greater than 1. The recommended weight limit (RWL) given by CATIA software is 11.987 kg, and the lifting index (LI) for 20 kg weight is 1.67, which appears to be higher (Waters et al., 1993).

Based on the analytical results of RULA, REBA, biomechanical analysis and lifting index extracted from the worksheet and CATIA V5 software, excavation workers are working on physically demanding work with high load on the vertebral segment L4/L5. Therefore, it is necessary to try to reduce this load on the spine.

The design and modelling of the new prototype Iron-Pan developed in CATIA to achieve a better working posture. RULA, REBA, biomechanical and lifting analysis are performed on the manikin postures to check the variation in the manikin posture while working with the new prototype Iron-Pan. The results show that the RULA and REBA scores are reduced while performing all the tasks using a newly developed prototype Iron-Pan. RULA and REBA worksheet scores show that the jobs that are very high risk have now become medium to low risk while using a newly developed Iron-Pan. Initially, RULA and REBA scores indicate that the lumbar, shoulders, and arms/hands were exposed to high ergonomic risk and are now at lower risk using a newly developed Iron-Pan.

Biomechanical analysis results for job-1 show that although the compression force is slightly increased, the joint shear load on L4/L5 is significantly reduced. For job 2, all weights' compression and shear forces have been reduced. In job 3, the compression force increases for all weight lifting, but it is below the maximum allowable limit however the joint shear load is decreased. For job 4, the compression force for all weights lifted decreases but increases in joint shear load. In job 4, initially, the labourers had to bend forward more than 30 degrees from

the lumbar and also worked in a twisting position, which did not have to bend and twist after using a newly developed Iron-Pan, thus reducing the compression force and joint shear load.

The lifting result showed that for job 2, LI is higher than 1 when lifting 20 kg of weight, which is higher than the recommended index. However, for job-3 and job-4, LI is more than 1 for lifting more than 15 kg. Weight up to 15 kg is recommended for lifting from ground level, while 6 kg is recommended for chest level, and 10 kg is recommended for receiving at surface level. The study concludes that 6-10 kg weight is the right weight for all jobs of excavation work.

Labourers do not need to bend more than 30° in all proposed lifting techniques using the new prototype pan. For all jobs, the lifting capacity of the soil must be limited to 10 kg to reduce the adverse effects of weight and to work in awkward positions.

Studies have shown that lifting weights is directly proportional to the load. The weight on the vertebrae increases as the weight increases and decreases as the weight decreases. Studies have also revealed that the compression force is higher when labourers work with straight vertebrae, and the shear load increases when labourers work by flexion position.

The results of RULA, REBA, biomechanical and lifting analysis show that the proposed new concept iron-pan with long handle and bottom pan can reduce ergonomic risk while working in awkward position, collecting soil in iron-pan, lifting iron-pan, throwing soil outside the pit or passing of iron-pan to the outside labourer and receiving iron-pan by the outside labourers.

Conclusion

This study modelled and evaluated five conventional working postures of excavating labourers in CATIA. The results of conventional working postures show high compressive and shear load acting at L4/L5 of the spinal cord of labourers who require intervention to reduce vertebrae exposure risk at construction sites. Result of RULA, REBA, biomechanical and lifting showed that excavation labourers work at high ergonomic risk when working with conventional methods and tools. Working in awkward postures, collecting excavated soil in the conventional Iron-Pan, lifting the iron-pan with without proper holding or coupling device, working overhead for throwing topsoil outside the pit or passing the Iron-Pan to the outside labourer, receiving the iron-pan by the outside labourer standing at the poor work surface are some of the causes.

The new prototype iron-pan was designed and modelled in CATIA. Also modelled and evaluated working postures for four various jobs using a newly developed Iron-Pan. The results show that the newly developed Iron-Pan is useful for reducing ergonomic risk and has been shown to have the potential to reduce the exposure to L4/L5 of the vertebrae of the excavating labourers.

Acknowledgements

The Authors gratefully acknowledge the research fellowship granted by MHRD India under the QIP scheme run by AICTE New Delhi. The authors also acknowledge gratitude to the group of workers and people who admitted the request to conduct the study, people who took part in the study and people who guided them.

Conflict of interest

There is no conflict of interest to disclose.

References

- Antwi-Afari, M. F., Li, H., Edwards, D. J., Pärn, E. A., Seo, J., & Wong, A. Y. L. (2017). Biomechanical analysis of risk factors for work-related musculoskeletal disorders during repetitive lifting task in construction workers. *Automation in Construction*, 83, 41–47. <https://doi.org/10.1016/j.autcon.2017.07.007>
- Chen, J., Qiu, J., & Ahn, C. (2017). Construction worker's awkward posture recognition through supervised motion tensor decomposition. *Automation in Construction*, 77, 67–81. <https://doi.org/10.1016/j.autcon.2017.01.020>
- Figlali, N., Cihan, A., Esen, H., Figlali, A., Cesmeci, D., Gullu, M. K., & Yilmaz, M. K. (2015). Image processing-aided working posture analysis: I-OWAS. *Computers & Industrial Engineering*, 85, 384–394. <https://doi.org/10.1016/j.cie.2015.03.011>
- Gajbhiye, M., Das, S., Das, C., & Banerjee, D. (2023). The pervasiveness of work-related Musculoskeletal Disorders on Indian construction workers. *International Journal of Experimental Research and Review*, 31 (Spl. Volume), 203-221. <https://doi.org/10.52756/10.52756/ijerr.2023.v31spl.019>
- Gajbhiye, M. T., Banerjee, D., & Nandi, S. (2022). Causes, Symptoms and Effect of Physical Risk Factors for the Development of Work-Related Musculoskeletal Disorders (WRMSD) Among

- Manual Construction Workers and Labourers in India and Intervention Through Ergonomics- A Case Study of Individual House Construction. In: Singh, L.P., Bhardwaj, A., Iqbal, R., Khanzode, V. (eds) Productivity with Health, Safety, and Environment. HWWE 2019. Design Science and Innovation. Springer, Singapore.
https://doi.org/10.1007/978-981-16-7361-0_15
- Hlavkova, J., Lebeda, T., Tichy, T., Gadourek, P., Urban, P., Nakladalova, M., Lastovkova, A., Fenclova, Z., Ridzon, P., Ehler, E., Richter, M., Pesakova, L., & Pelcova, D. (2016). Evaluation of Lumbar Spine Load by Computational Method in Order to Acknowledge Low-back Disorders as Occupational Diseases. *Cent. Eur. J. Public Health*, 24(1), pp. 58-67.
<https://doi.org/10.21101/cejph.a4332>
- Kim, D. I., Yoo, W. S., Cho, H., & Kang, K. I. (2014). A fuzzy AHP-based decision support model for quantifying failure risk of excavation work. *KSCE Journal of Civil Engineering*, 18(7), 1966–1976.
<https://doi.org/10.1007/s12205-014-0538-7>
- Kivi, P., & Mattila, M. (1991). Analysis and improvement of work postures in the building industry: application of the computerised OWAS method. *Applied Ergonomics*, 22(1), 43–48.
[https://doi.org/10.1016/0003-6870\(91\)90009-7](https://doi.org/10.1016/0003-6870(91)90009-7)
- Kushwaha, D. K., & Kane, P. V. (2016). Ergonomic assessment and workstation design of shipping crane cabin in steel industry. *International Journal of Industrial Ergonomics*, 52, 29-39.
<https://doi.org/10.1016/j.ergon.2015.08.003>
- Patel, D. A., & Jha, K. N. (2016). An estimate of fatal accidents in Indian construction. In: P W Chan and C J Neilson (Eds.) Proceedings of the 32nd Annual ARCOM Conference, 5-7 September 2016, Manchester, UK, Association of Researchers in Construction Management, (1), pp. 577-586.
[https://www.researchgate.net/publication/308155592_AN_ESTIMATE_OF_FATAL_](https://www.researchgate.net/publication/308155592_AN_ESTIMATE_OF_FATAL_ACCIDENTS_IN_INDIAN_CONSTRUCTION)
- ACCIDENTS_IN_INDIAN_CONSTRUCTION
- Pavlovic-Veselinovic, S., Hedge, A., & Veselinovic, M. (2016). An ergonomic expert system for risk assessment of work-related musculoskeletal disorders. *International Journal of Industrial Ergonomics*, 53, 130–139.
<https://doi.org/10.1016/j.ergon.2015.11.008>
- Roman-Liu, D. (2014). Comparison of concepts in easy-to-use methods for MSD risk assessment. *Applied Ergonomics*, 45(3), 420–427.
<https://doi.org/10.1016/j.apergo.2013.05.010>
- Sanchez-Lite, A., Garcia, M., Domingo, R., & Angel Sebastian, M. (2013). Novel Ergonomic Postural Assessment Method (NERPA) Using Product-Process Computer Aided Engineering for Ergonomic Workplace Design. *PLoS ONE*, 8(8), e72703: 1-12.
<https://doi.org/10.1371/journal.pone.0072703>
- Tahmasebi, R., Anbarian, M., Torkashvand, S., Motamedzade, M., & Farhadian, M. (2017). Ergonomic Evaluation of Welders' Posture and Biomechanical Analysis of Loads on the Spine by CATIA Software in Iran Gas Transmission Company. *Journal of Occupational Hygiene Engineering*, 4(3), 17-25.
<http://johe.umsha.ac.ir/article-1-290-en.html>
- Valero, E., Sivanathan, A., Bosché, F., & Abdel-Wahab, M. (2016). Musculoskeletal disorders in construction: A review and a novel system for activity tracking with body area network. *Applied Ergonomics*, 54, 120–130.
<https://doi.org/10.1016/j.apergo.2015.11.020>
- Veljovic, F., Burak, S., Voloder, A., Kulovac, B., Jahic, D., & Kadic, F. (2019). Influence of school backpacks on spinal column load in primary school students. *Periodicals of Engineering and Natural Sciences*, 7(4), 1768-1775.
<http://pen.ius.edu.ba/index.php/pen/article/view/894/445>
- Waters, T. R., Putz-Anderson, V., Garg, A., & Fine, L. J. (1993). Revised NIOSH equation for the design and evaluation of manual lifting tasks. *Ergonomics*, 36(7), 749–776.
<https://doi.org/10.1080/00140139308967940>

How to cite this Article:

Manoj T. Gajbhiye, Suman Das, Chandan Das, Debamalya Banerjee (2023). Postural Assessment of Indian Excavation Workers and Prototype Design of Virtual Iron-Pan. *International Journal of Experimental Research and Review*, 36, 388-404.

DOI : <https://doi.org/10.52756/ijerr.2023.v36.034>

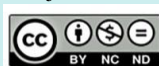

This work is licensed under a Creative Commons Attribution-NonCommercial-NoDerivatives 4.0 International License.